

Internal Gear Unit

for motor/pump function
Series QXM

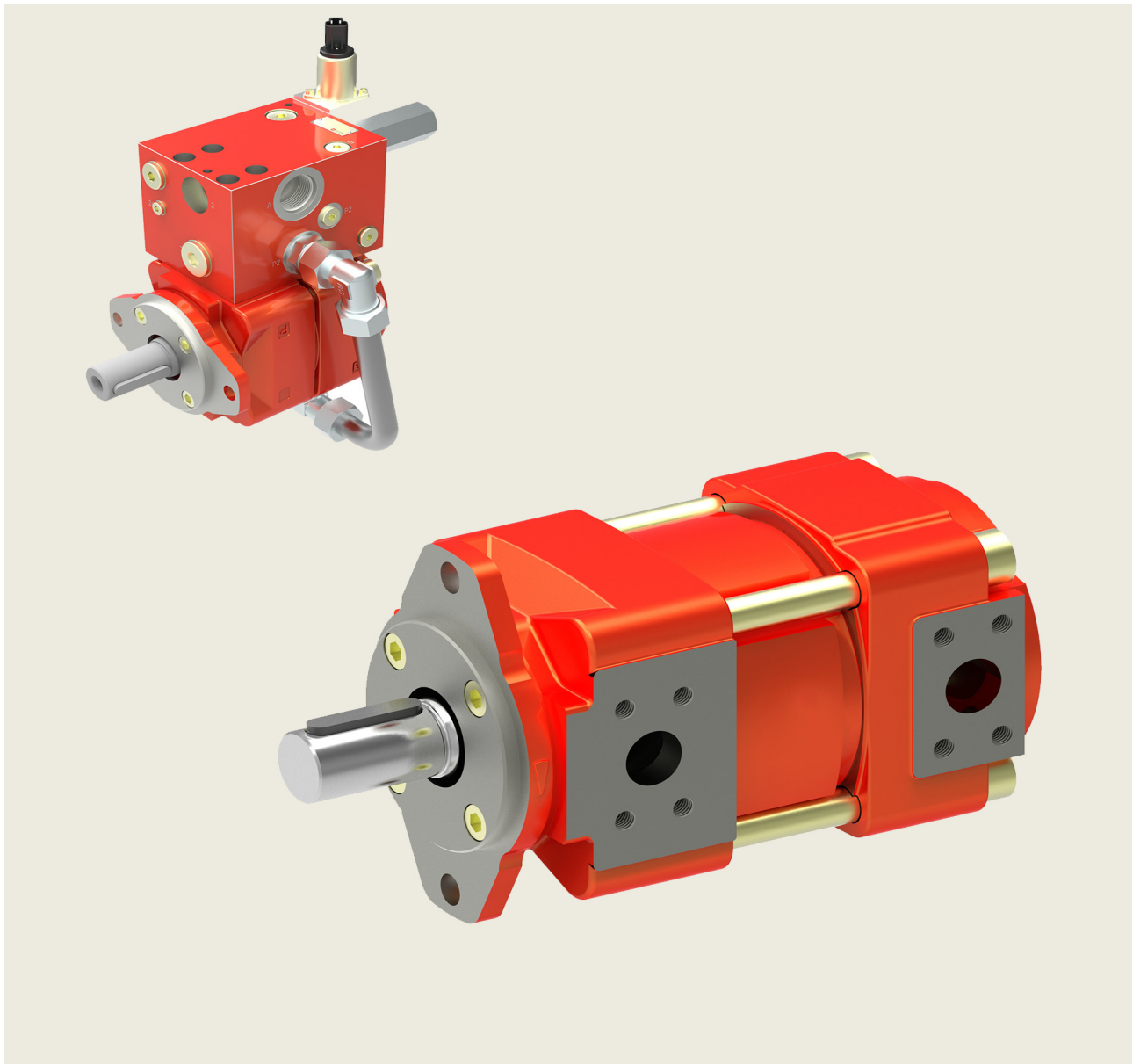

Contents	Page
1	General 5
1.1	Product description 5
1.2	Advantages 5
1.3	Application 5
1.4	ATEX compliant explosion protection 5
2	Technical data 5
2.1	General 5
2.2	Main characteristics for pressure range 1 6
2.3	Main characteristics for pressure range 2 7
2.4	Main characteristics for pressure range 3 7
3	Performance graphs 8
3.1	Pressure range 1 8
3.2	Pressure range 2 9
3.3	Pressure range 3 10
3.4	Noise level (Lp) 11
4	Dimensions 11
4.1	Pressure range 1 12
4.2	Pressure range 2 12
4.3	Pressure range 3 13
4.4	Ordering details 13
4.5	Ordering example 13
4.6	Standard configuration 13
4.7	Special features 14
4.8	Direction of rotation 14
5	Fluid cleanliness 14
6	Note 14
7	Fluid cleanliness 14
8	Operational reliability 14
9	Accessories 15
9.1	Pipe flanges - high pressure type 15
9.2	Low pressure type 16
9.3	Bolt-on valves - SAE J518 code 61 / ISO 6162-1 pattern 17

1 General

1.1 Product description

The QXM drive unit can be used in open- and closed-loop hydrostatic drives, and can operate both as a pump and as a motor.

This flexibility offers possibilities for various applications, one example being the raising and lowering of loads. The QXM works as a pump to lift the load and recovers energy when the load is being lowered.

Used as a fully bi-directional pump/motor (four-quadrant operation), the unit controls a complete motion cycle of a cylinder. Fast acceleration/deceleration sequences can be achieved.

The unit is based on the well-known QX internal gear pump, which is distinguished by its very low noise levels and almost imperceptible pressure pulsations. The large number of closely spaced sizes ensures that the right size is always available for every application.

1.3 Application

- Injection molding machines
- Hydraulic presses
- Flight simulators

1.4 ATEX compliant explosion protection

The internal gear unit QXM is suitable for application in hazardous areas and complies with the following guidelines:

ATEX directive 2014/34/EU
 group II
 equipment category 3
 atmosphere G
 temperature class T3 and T4

1.2 Advantages

- very low noise levels
- negligible pressure pulsations
- 5802 PSI maximum pressure
- hydrodynamic bearing support ensures long service life
- suitable for special fluids such as HFB, HFC, HFD and bio-degradables
- suitable for variable-speed operation
- 2- and 4-quadrant operation is possible
- optimised flow path cross-sections and special gear profile give low susceptibility to cavitation

- Wind-power plants
- Lift / elevator drives
- Winches



II 3 G EEx c II T4
 $-20^{\circ}\text{C} \leq T_a \leq +40^{\circ}\text{C}$



II 3 G EEx c II T3
 $-20^{\circ}\text{C} \leq T_a \leq +80^{\circ}\text{C}$

2 Technical data

2.1 General

Characteristics	Unit	Description, value
Installation attitude		unrestricted
Mounting method (standard)		oval 2-hole flange to ISO 3019/1 (SAE): QXM 3-6 oval 2-hole flange to ISO 3019/2 (metric) QXM 2+8
Direction of rotation		unrestricted
Drive method		in-line, by a flexible coupling
Hydraulic fluid		HLP mineral oils to DIN 51524, Part 2 HFB, HFD and HFC fluids to VDMA 24317 other fluids - contact Bucher Hydraulics
Max. admissible level of contamination of the hydraulic fluid		ISO 4406 class 20/18/15

Characteristics	Unit	Description, value
Operating viscosity Starting viscosity	ft ² /s (mm ² /s)	1.08 ... 10.76 (10 ... 100 mm ² /s) 1.08 ... 32.29 (10 ... 300 mm ² /s) (higher values, contact Bucher Hydraulics)
Hydraulic fluid temperature	°F (°C)	HLP-mineral oils -4 (-20°C) min. / +176 (+80°C) max. / HFC +122 (+50°C) max. range for max. long life cycle +86 ... +140 (+30°C ... +6°C considering viscosity field)
Max. pressure at drain port	PSI (bar)	22 (1,5 bar) absolute (higher values, contact Bucher Hydraulics)
Accumulated pressure restriction		Port P ₁ + Port P ₂ ≤ continuous-/intermittent pressure

IMPORTANT: The main characteristics are valid for hydraulic oils DIN 51524 with a viscosity of 42mm²/s.

2.2 Main characteristics for pressure range 1

Type	Displacement		minimum Motor Speed ⁵⁾		max. Speed ³⁾		Operating pressure		Torque ²⁾ lb-in (Nm)
	in ³ /rev(cm ³ /U)		RPM (min ⁻¹)		RPM (min ⁻¹)		PSI (bar)		
	nominal	effective ⁶⁾	Operating pressure on inlet side		Pump ⁴⁾ operating	Motor operating	continuous	Intermittent ¹⁾	
		...50%	...100%						
QXM21-010	0.61 (010)	0.62 (10.3)	1000	2500	4000	5500	2321 (160)	3045 (210)	221 (25)
QXM21-012	0.73 (012)	0.76 (12.6)			3600		1813 (125)	2320 (160)	
QXM21-016	0.97 (016)	0.97 (15.9)			3200		1450 (100)	1813 (125)	
QXM31-020	1.22 (020)	1.22 (20.0)	800	2000	3200	5000	2321 (160)	3045 (210)	443 (50)
QXM31-025	1.52 (025)	1.53 (25.2)			3000		1813 (125)	2320 (160)	
QXM31-032	1.95 (032)	1.95 (32.1)			2700		1450 (100)	1813 (125)	
QXM41-040	2.44 (040)	2.47 (40.6)	600	1500	2700	4600	2321 (160)	3045 (210)	885 (100)
QXM41-050	3.05 (050)	3.06 (50.2)			2350		1813 (125)	2320 (160)	
QXM41-063	3.84 (063)	3.93 (64.5)			2050		1450 (100)	1813 (125)	
QXM51-080	4.88 (080)	4.83 (79.3)	600	1500	2050	4000	2321 (160)	3045 (210)	1770 (200)
QXM51-100	6.10 (100)	6.13 (100.6)			1900		1813 (125)	2320 (160)	
QXM51-125	7.62 (125)	7.73 (126.7)			1620		1450 (100)	1813 (125)	
QXM61-160	9,76 (160)	9,74 (159.7)	600	1500	1500	3200	2321 (160)	3045 (210)	3540 (400)
QXM61-200	12.20 (200)	12.27 (201.1)			1350		1813 (125)	2320 (160)	
QXM61-250	15.25 (250)	15.15 (248.4)			1200		1450 (100)	1813 (125)	
QXM81-315	19,22 (315)	19,76 (323.9)	600	1200	1200	3000	2321 (160)	3045 (210)	7081 (800)
QXM81-400	24.40 (400)	24.41 (400.1)			1100		1813 (125)	2320 (160)	
QXM81-500	30.51 (500)	30.23 (495.4)			1000		1450 (100)	1813 (125)	

1) Intermittent pressure for max. 20 sec/min but not more than 10% of the duty cycle.

2) Theoretical value at the maximum permitted continuous pressure. For starting torques, see section 3.

3) For higher speed contact us.

4) Min. inlet pressure 1 bar absolute.

5) Recommended speed. For less speed the pressure must be reducing (linear rate). For customized working cycle contact Bucher Hydraulics.

6) Due to manufacturing tolerances, there may be slight variations in the displacement.

2.3 Main characteristics for pressure range 2

Type	Displacement		minimum Motor Speed ⁵⁾		Max. Speed ³⁾		Operating pressure on outlet side ¹⁾		Torque ²⁾
	in ³ /rev (cm ³ /U)		RPM (min ⁻¹)		RPM (min ⁻¹)		PSI (bar)		
	nominal	effective ⁶⁾	Operating pressure on inlet side		Pump ⁴⁾ operating	Motor operating	continuous	Intermittent ¹⁾	
...50%			...100%						
QXM22-005	0.30 (005)	0.31 (5.1)	1650	3000	3250	6000	3046 (210)	3626 (250)	150 (17)
QXM22-006	0.38 (006)	0.38 (6.3)							186 (21)
QXM22-008	0.48 (008)	0.48 (8.0)							235 (26.5)
QXM32-010	0.61 (010)	0.61 (10.0)	1400	2500	3050	5500	3046 (210)	3626 (250)	296 (33.5)
QXM32-012	0.73 (012)	0.76 (12.6)							372 (42)
QXM32-016	0.97 (016)	0.95 (15.6)							460 (52)
QXM42-020	1.22 (020)	1.20 (20.3)	1000	1800	2900	5000	3046 (210)	3626 (250)	602 (68)
QXM42-025	1.52 (025)	1.53 (25.1)							743 (84)
QXM42-032	1.95 (032)	1.97 (32.3)							956 (108)
QXM52-040	2.44 (040)	2.38 (39.1)	1000	1800	2500	4500	3046 (210)	3626 (250)	1159 (131)
QXM52-050	3.05 (050)	3.06 (50.3)							1496 (169)
QXM52-063	3.84 (063)	3.86 (63.4)							1876 (212)
QXM62-080	4.88 (080)	4.86 (79.8)	1000	1800	2250	4000	3046 (210)	3626 (250)	2732 (268)
QXM62-100	6.10 (100)	6.13 (100.5)			2050				2983 (337)
QXM62-125	7.62 (125)	7.57 (124.2)			1800				3682 (416)
QXM82-160	9.76 (160)	9.87 (161.9)	1000	1800	1600	3500	3046 (210)	3626 (250)	4815 (544)
QXM82-200	12.20 (200)	12.20 (200)			1500				5939 (671)
QXM82-250	15.25 (250)	15.11 (247.7)			1350				7364 (832)

2.4 Main characteristics for pressure range 3

Type	Displacement		minimum Motor Speed ⁵⁾		max. Speed ³⁾		Operating pressure on outlet side		Torque ²⁾
	in ³ /Rev (cm ³ /U)		RPM (min ⁻¹)		RPM (min ⁻¹)		PSI (bar)		
	nominal	effective ⁶⁾	Operating pressure on inlet side		Pump ⁴⁾ operating	Motor operating	continuous	Intermittent ¹⁾	
...50%			...100%						
QXM23-005	0.30 (005)	0.31 (5.1)	1200	2500	3250	6000	4641 (320)	5802 (400)	230 (26)
QXM23-006	0.36 (006)	0.38 (6.3)							283 (32)
QXM23-008	0.48 (008)	0.48 (7.9)							363 (41)
QXM33-010	0.61 (010)	0.61 (10.0)	1000	2000	3050	5500	4641 (320)	5802 (400)	451 (51)
QXM33-012	0.73 (012)	0.76 (12.6)							566 (64)
QXM33-016	0.97 (016)	0.95 (15.6)							708 (80)
QXM43-020	1.22 (020)	1.23 (20.3)	750	1500	2900	5000	4641 (320)	5802 (400)	912 (103)
QXM43-025	1.52 (025)	1.53 (25.1)							1133 (128)
QXM43-032	1.95 (032)	1.97 (32.3)							1452 (164)
QXM53-040	2.44 (040)	2.38 (39.1)	750	1500	2500	4500	4641 (320)	5802 (400)	1770 (200)
QXM53-050	3.05 (050)	3.06 (50.3)							2275 (257)
QXM53-063	3.84 (063)	3.86 (63.4)							2859 (323)
QXM63-080	4.88 (080)	4.86 (79.8)	750	1500	2250	4000	4641 (320)	5802 (400)	3611 (408)
QXM63-100	6.10 (100)	6.13 (100.5)			2050				4549 (514)
QXM63-125	7.62 (125)	7.57 (124.2)			1800				5620 (635)
QXM83-160	9.76 (160)	9.87 (161.9)	750	1500	1600	3500	4641 (320)	5802 (400)	7328 (828)
QXM83-200	12.20 (200)	12.20 (200.0)			1500				9054 (1023)
QXM83-250	15.25 (250)	15.11 (247.7)			1350				11214(1267)

1) Intermittent pressure for max. 20 sec/min but not more than 10% of the duty cycle.

2) Theoretical value at the maximum permitted continuous pressure. For starting torques, see section 3.

3) For higher speed contact us.

4) Min. inlet pressure 1 bar absolute.

5) Recommended speed. For less speed the pressure must be reducing (linear rate). For customized working cycle contact Bucher Hydraulics.

6) Due to manufacturing tolerances, there may be slight variations in the displacement.

3 Performance graphs

3.1 Pressure range 1

3.1.1 Volumetric efficiency

Measured with $n = 1450 \text{ RPM (min}^{-1}\text{)}$
Viscosity 210 S.U.S (42 mm²/s)

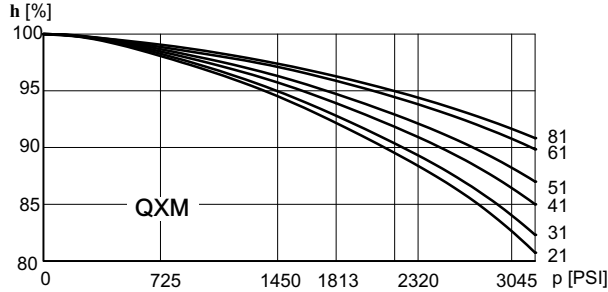

3.1.2 Hydro-mechanical efficiency

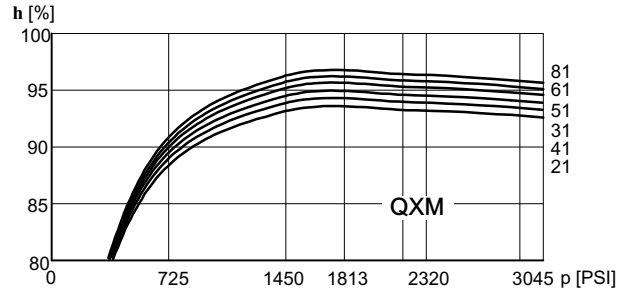

3.1.3 Starting torque

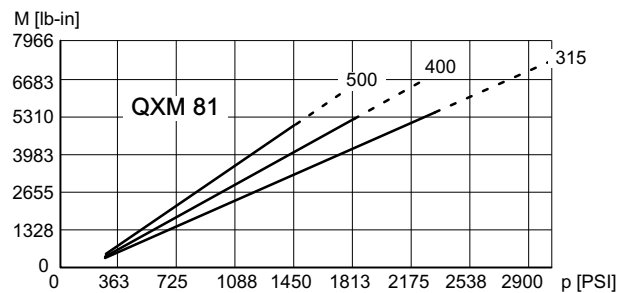
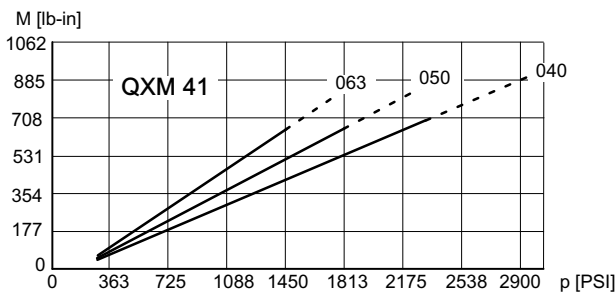
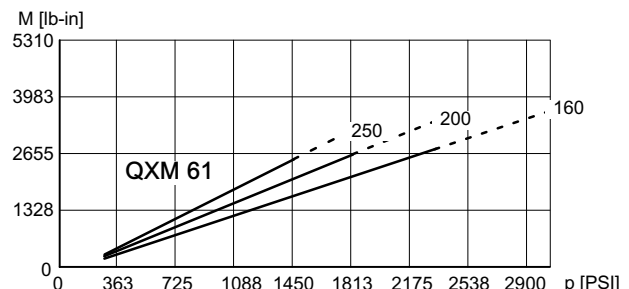
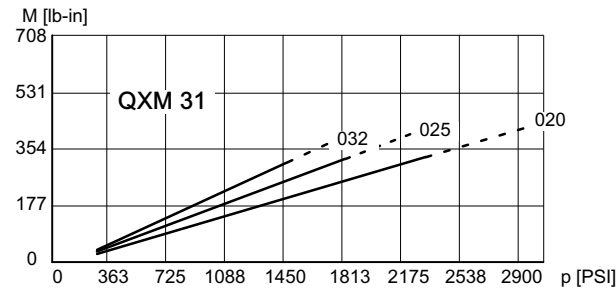
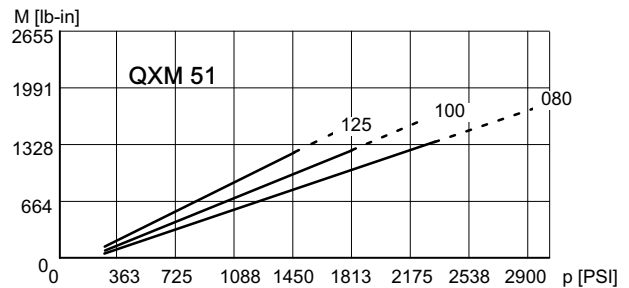
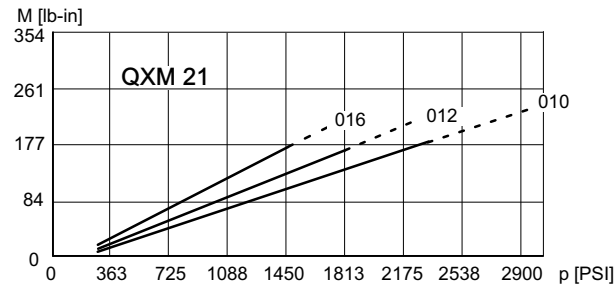

3.1.4 Maximum pressure accumulation at $P_1 + P_2$

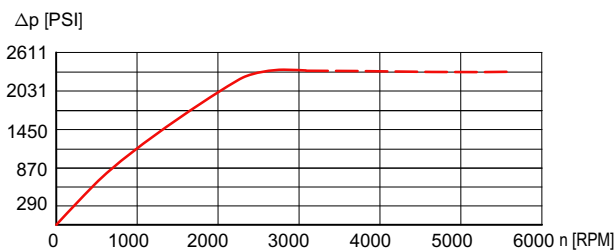

--- = Dependent on frame size (see 2.2)

3.2 Pressure range 2

3.2.1 Volumetric efficiency

Measured with viscosity 42 mm²/s, speed 1450 RPM (min⁻¹)

Solid line = continuous pressure / dashed line = max. intermittent pressure

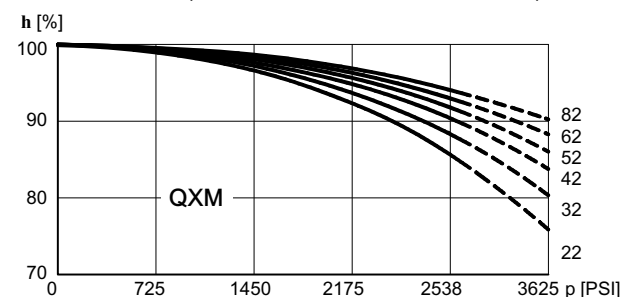

3.2.2 Hydro-mechanical efficiency

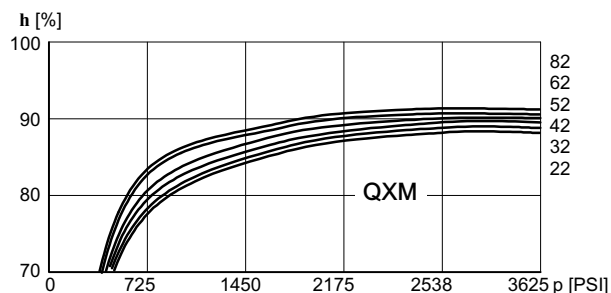

3.2.3 Starting torque

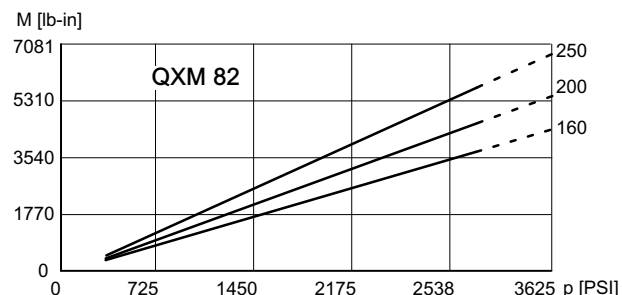
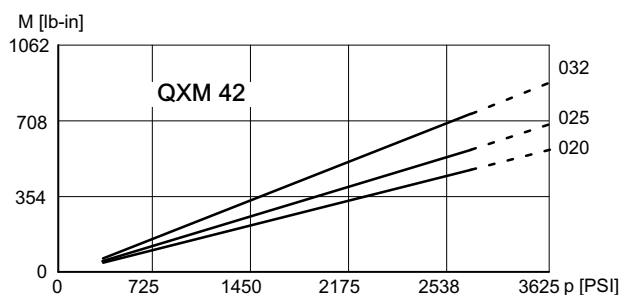
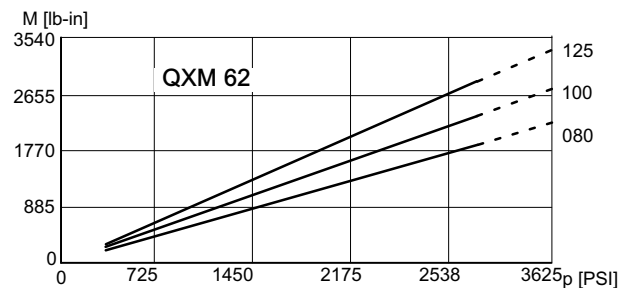
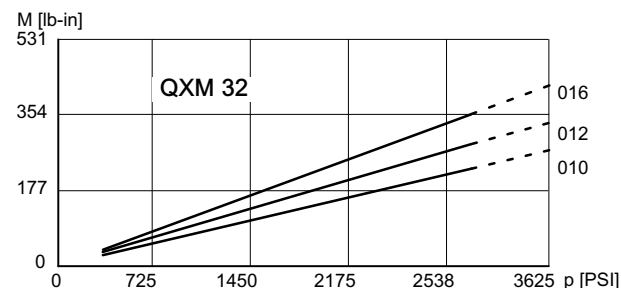
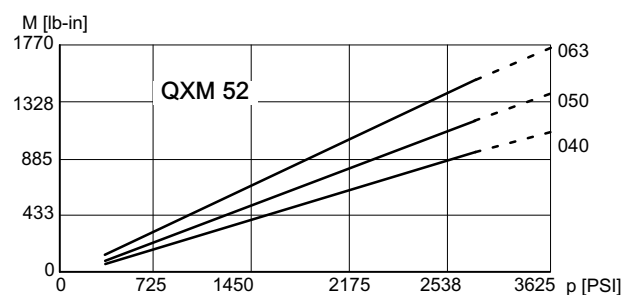
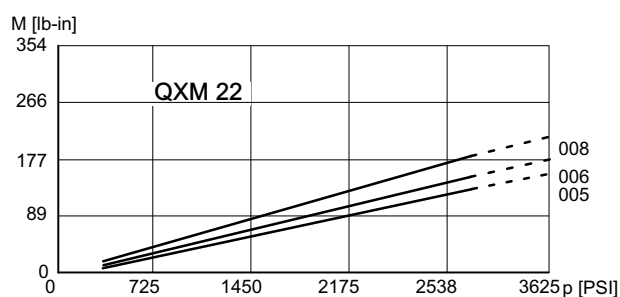

3.2.4 Maximum pressure accumulation at P₁ + P₂

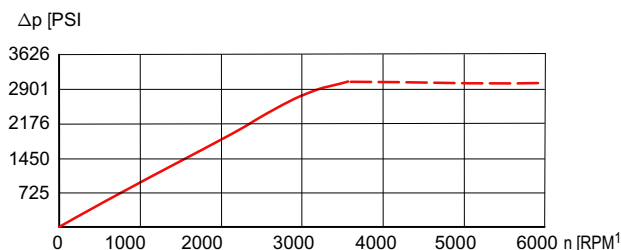

--- = Dependent on frame size (see 2.3)

3.3 Pressure range 3

3.3.1 Volumetric efficiency

Measured with viscosity 42 mm²/s, speed 1450 RPM (min⁻¹)

Solid line = continuous pressure / dashed line = max. intermittent pressure

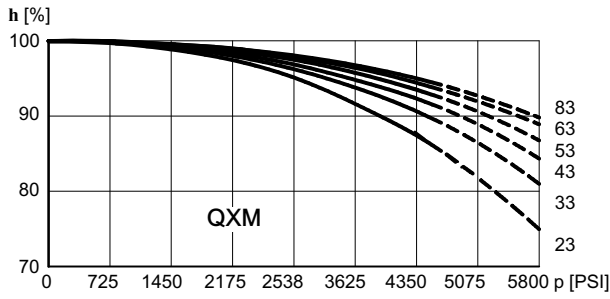

3.3.2 Hydro-mechanical efficiency

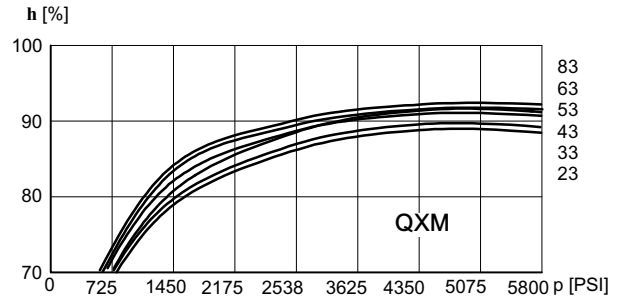

3.3.3 Starting torque

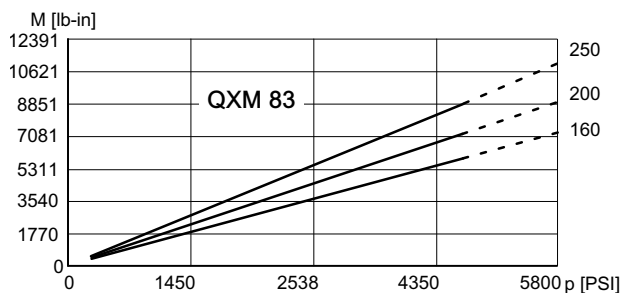
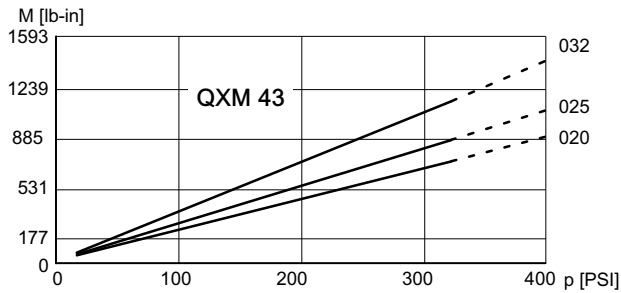
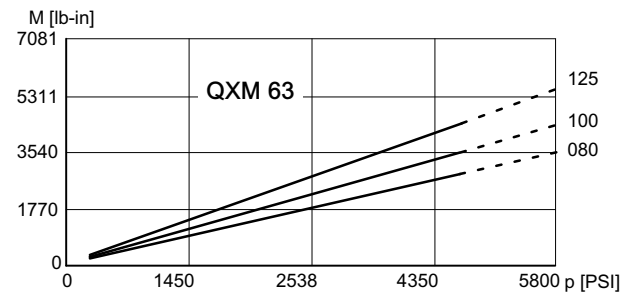
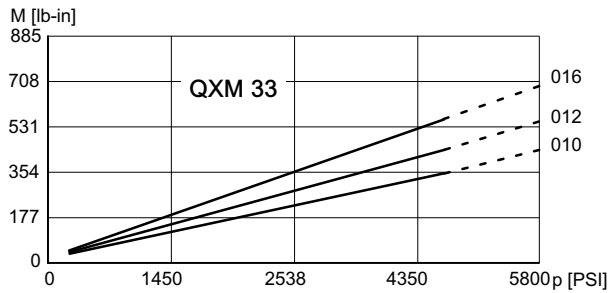
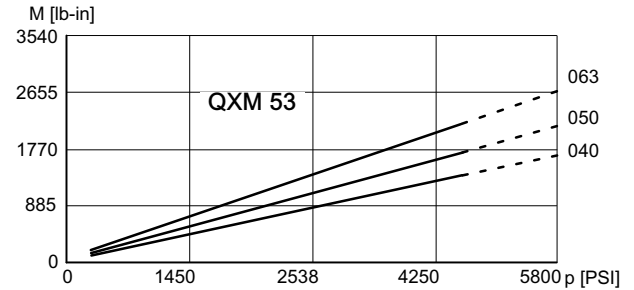
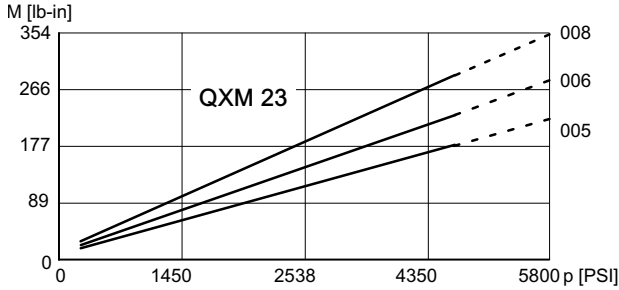

3.3.4 Maximum pressure accumulation at P₁ + P₂

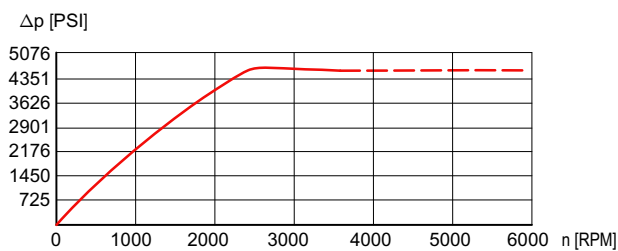

--- = Dependent on frame size (see 2.4)

3.4 Noise level (L_p)

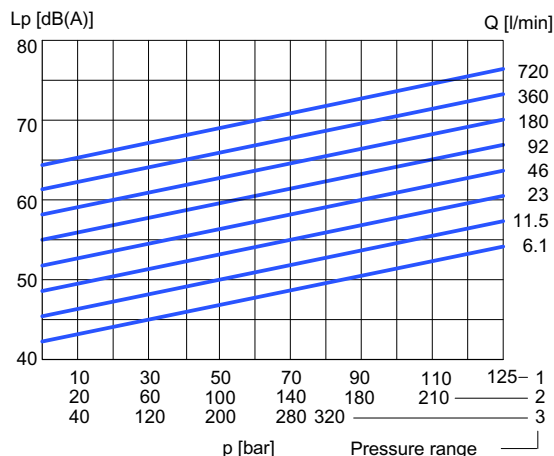

Measured to DIN 45635 Part 26, in low-echo noise Measurement chamber; measurement distance 1 m; speed $n = 1500$ rpm; viscosity = 210 S.U.S (42 mm²/s)

4 Dimensions in inch (mm)

4.1 Size 2 - 4

Frame size		2			3			4		
Pressure range		1	2	3	1	2	3	1	2	3
Service ports to SAE J518 ¹⁾	P1, P2	G1/2" ³⁾ thread			G 3/4" ³⁾ thread			1"		
Drain port to DIN 3852 Part 2	P _L	G1/4"								
Mounting: oval 2-hole flange to ISO 3019/1 (SAE-size 3-6) ISO 3019/2 (Metr.-sizes 2+8)	A	7.15 (118)			5.20 (132)			6.70 (170)		
	B (SAE)	-			4.17 (106)			5.75 (146)		
	B (Metr.)	3.93 (100)			4.29 (109)			5.51 (140)		
	C	0.35 (9)			0.43 (11)			0.55 (14)		
	N (SAE)	-			3.25 ^{-0.002} (82.55 ^{-0.05})			4 ^{-0.002} (101.6 ^{-0.05})		
	N _(Metr.)	2.48 h8 (63 h8)			3.15 h8 (80 h8)			3.93 h8 (100 h8)		
	O	0.33 (8.5)						0.41 (10.5)		
V	0.24 (6)						0.28 (7)			
Shaft end: parallel, to ISO/R775 ²⁾	D	0.79 j6 (20 j6)			0.98 j6 (25 j6)			1.26 j6 (32 j6)		
	E	1.42 (36)			1.65 (42)			2.28 (58)		
	F	0.24 (6)			0.31 (8)			0.39 (10)		
	G	0.89 (22.5)			1.10 (28)			1.38 (35)		
	I	1.77 (45)			1.97 (50)			2.68 (68)		
Housing	K	1.48 (37.5)			1.73 (44)			2.07 (52.5)		
	L	5.49 (139.5)	4.78 (121.5)	6.16 (156.5)	6.51 (165.5)	5.72 (145.5)	7.5 (190.5)	8.01 (203.5)	7.00 (178)	9.19 (233.5)
	M	-	2.16 (55)	3.54 (90)	-	2.73 (69.5)	4.50 (114.5)	-	3.42 (87)	5.63 (143)
	T1	1.69 (43)			2.10 (53.5)			2.61 (66.5)		
	T2	1.69 (43)			2.10 (53.5)			2.61 (66.5)		
	Z	3.93 (100)			4.72 (120)			4.92 (125)		
	W	3.15 (80)			3.93 (100)			4.84 (123)		
Weight	[lbs] (kg)	13 (6)	12 (5)	14 (6.5)	22 (10)	20 (9)	27 (12)	42 (19)	38 (17)	44 (20)

1) For SAE J518 code 61 bzw. ISO6162-1 pipe flange dimensions see section 9.

2) For other shaft ends contact Bucher Hydraulics.

3) Threaded ports to DIN 3852 Part 2.

4.2 Size 5 - 8

Frame size		5			6			8		
Pressure range		1	2	3	1	2	3	1	2	3
Service ports to SAE J518 ¹⁾	P1, P2	1 1/4"			1 1/2"			2"		
Drain port to DIN 3852 Teil 2 Part 2	P _L	G1/4"			G 3/8"			G1/2"		
Mounting: oval 2-hole flange to ISO 3019/1 (SAE - size 3-6) ISO 3019/2 (Metr. - sizes 2+8)	A	8.35 (212)			10.51 (267)			12.99 (330)		
	B _(SAE)	7.13 (181)			9.02 (229)			-		
	B _(Metr.)	7.09 (180)			8.82 (224)			11.02 (280)		
	C	0.71 (18)			0.87 (22)			1.02 (26)		
	N _(SAE)	5 -0.002 (127 -0.05)			6 -0.002 (152.4 -0.05)			-		
	N _(Metr.)	4.92 h8 (125 h8)			6.30 h8 (160 h8)			7.87 h8 (200 h8)		
	O	0.49 (12.5)			0.65 (16.5)			0.79 (20)		
Shaft end: parallel, to ISO/R775 ²⁾	V	0.28 (7)			0.28 (7)			0.35 (9)		
	D	1.57 j6 (40 j6)			1.97 j6 (50 j6)			2.48 j6 (63 j6)		
	E	3.23 (82)			3.23 (82)			4.13 (105)		
	F	0.47 (12)			0.55 (14)			0.71 (18)		
	G	1.69 (43)			2.10 (53,5)			2.64 (67)		
Housing	I	3.62 (92)			3.62 (92)			4.61 (117)		
	K	2.38 (60.5)			2.91 (74)			3.54 (90)		
	L	9.58 (243.5)	8.32 (211.5)	11.08 (281.5)	11.33 (288)	9.80 (249)	13.34 (339)	14.21 (361)	13.03 (331)	16.89 (429)
	M	-	4.01 (102)	6.77 (172)	-	4.68 (119)	8.22 (209)	-	5.94 (151)	10.47 (266)
	T1	3.48 (88.5)			4.21 (107)	4.33 (110)		5.41 (137.5)		
	T2	3.48 (88.5)			4.21 (107)	4.33 (110)		5.41 (137.5)		
	Z	6.14 (156)			7.67 (195)			9.84 (250)		
W	6.49 (165)			7.99 (203)			1039 (264)			
Weight	[lbs] (kg)	75 (34)	68 (31)	90 (41)	130 (59)	124 (56)	168 (76)	284 (129)	269 (122)	342 (155)

1) For SAE J518 code 61 bzw. ISO6162-1 pipe flange dimensions see section 9.

2) For other shaft ends contact Bucher Hydraulics.

3) Threaded ports to DIN 3852 Part 2.

4.3 Pressure range 1

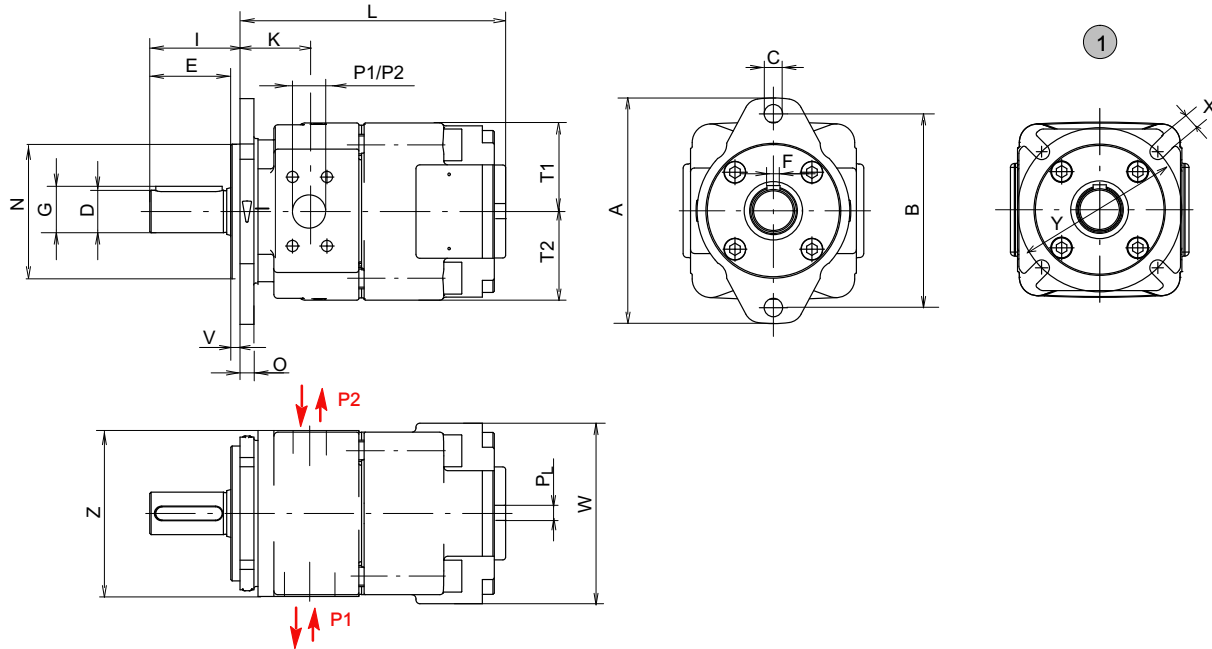

1 Option 66: 4-hole flange ISO 3019/2

4.4 Pressure range 2

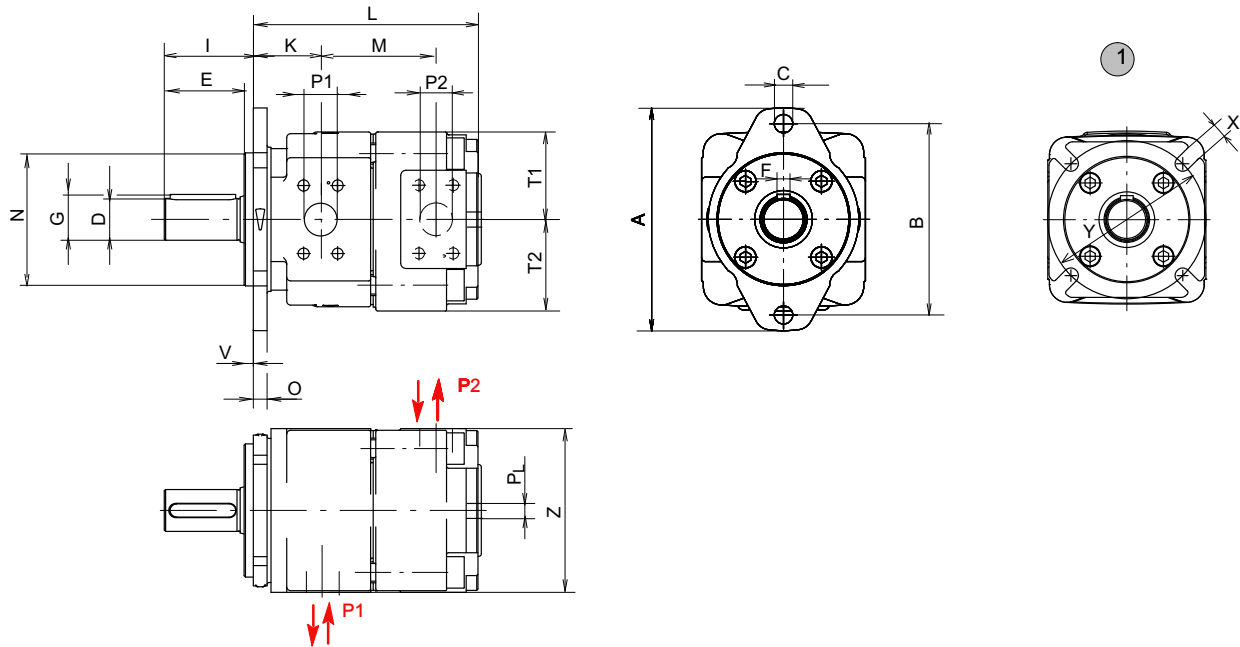

1 Option 66: 4-hole flange ISO 3019/2

4.5 Pressure range 3

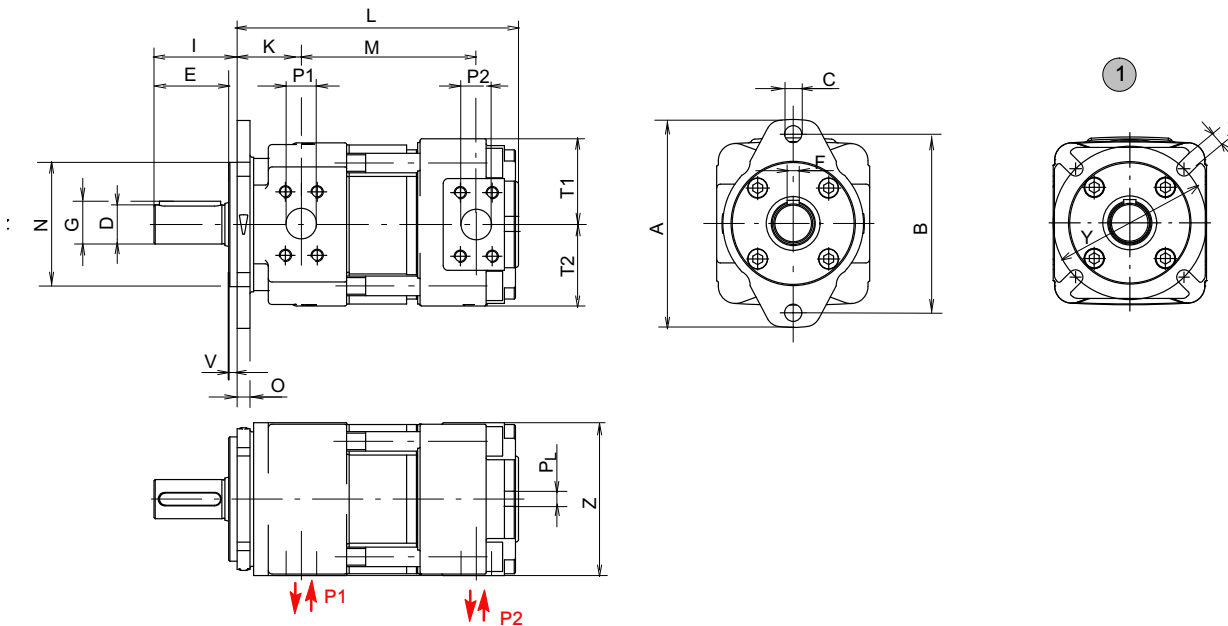

1 Option 66: 4-hole flange ISO 3019/2

4.6 Ordering details

		Q	X	M	5	3	-	0	4	0	N	*	*	*
Internal gear unit	= QXM													
Frame size	= 2 / 3 / 4 / 5 / 6 / 8													
Pressure range	= 1 / 2 / 3													
Geom. Displ./Consump. in in ³ /Rev (cm ³ /rev)	= 0.31 - 30.23 (5,1 - 495,4)													
Direction of rotation, unrestricted	= N (see section 4.10)													
Option	(to be inserted by the factory, see section 4.9 for a selection)													

4.7 Ordering example

Required: Internal gear unit QXM
 Displ./Consump.: 2.40 in³/rev (40 cm³/rev)
 Continuous pressure: 4350 PSI (300 bar)
 For use with mineral oil: HLP
 Ordering code: QXM53-040 N

4.8 Standard configuration

- Direction of rotation - unrestricted
- 2-hole mounting flange to ISO 3019/1;
Frame size QXM 3-6
- 2-hole mounting flange to ISO 3019/2;
Frame size QXM 2+8
- Nitrile seals
- Cylindrical shaft end to ISO R775
- Separate drain port in rear cover
- Ports P₁ + P₂ both the same size
- High pressure shaft seal
- Black priming, flange without priming

4.9 Options

- O = without priming
- 09 = FKM (Viton) seals, without priming
- 130 = 2-quadrant operation, service port dimensions as per QX pumps
2-hole mounting flange to ISO 3019/2 (metric)

For other special features contact Bucher Hydraulics.

4.10 Direction of rotation

Direction of rotation: right
(clockwise, viewed from the shaft end) = oil flows from P₁ to P₂

Direction of rotation: left
(counterclockwise, viewed from the shaft end) = oil flows from P₂ to P₁

5 Fluid cleanliness

QXM internal gear units require a fluid with a minimum cleanliness level of ISO 4406 code 20/18/15.

We recommend the use of fluids that contain anti-wear additives for mixed-friction operating conditions. Fluids without appropriate additives can reduce the service life of pumps and motors. The user is responsible for maintaining, and regularly checking, the fluid quality. Bucher Hydraulics recommends a load capacity of $\geq 30 \text{ N/mm}^2$ to Brugger DIN 51347-2.

6 Note

This catalogue is intended for users with specialist knowledge. The user must check the suitability of the equipment described herein in order to ensure that all of the conditions necessary for the safety and proper functioning of the system are fulfilled. If you have any doubts or questions concerning the use of these pumps, please consult Bucher Hydraulics.

7 Fluid cleanliness

Cleanliness class (RK) as per ISO 4406.

Code ISO 4406	Dirt particle number / 100 ml		
	$\geq 4 \mu\text{m}$	$\geq 6 \mu\text{m}$	$\geq 14 \mu\text{m}$
23/21/18	8000000	2000000	250000
22/20/18	4000000	1000000	250000
22/20/17	4000000	1000000	130000
22/20/16	4000000	1000000	64000
21/19/16	2000000	500000	64000
20/18/15	1000000	250000	32000
19/17/14	500000	130000	16000
18/16/13	250000	64000	8000
17/15/12	130000	32000	4000
16/14/12	64000	16000	4000
16/14/11	64000	16000	2000
15/13/10	32000	8000	1000
14/12/9	16000	4000	500
13/11/8	8000	2000	250

8 Operational reliability

To ensure a reliable operation and a long service life, a maintenance schedule must be prepared for the power unit, machine or system. The maintenance schedule must make sure that the provided or permissible operating conditions are adhered to over the period of use.

In particular, compliance with the following operating parameters must be ensured:

- The required oil cleanliness
- The operating temperature range
- The fluid level

Moreover, the QXM internal gear units and the system must be inspected at regular intervals for changes in the following parameters:

- Vibration
- Noise
- Differential temperature – fluid in the tank
- Foaming in the tank
- Freedom from leakage

Changes in these parameters indicate wear of components (e.g. drive motor, coupling, internal gear unit, etc.). The cause must be immediately pinpointed and eliminated.

To provide high operational reliability in the machine or system, we recommend continuous, automatic checks of the above parameters and an automatic shutdown in the case of changes that exceed the usual fluctuations within the provided operating range.

Commissioning see Operating Instructions 100-B-000014

9 Accessories

9.1 Pipe flanges - high pressure type

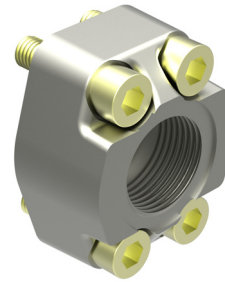
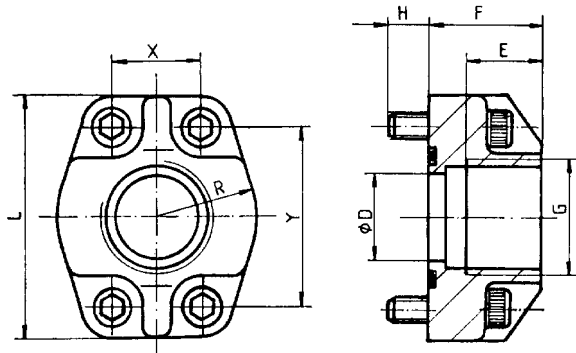

- Max. operating pressure 6092 PSI
- Flange size SAE J518 code 61 / ISO 6162-1
- Material: HST37

- for FKM (Viton) seals contact Bucher Hydraulics
- Threaded pipe flanges are spot-faced for DIN 2353 pipe fittings.

Order number	Ordering code	G (size)	D ϕ	E	F	H	L	R	X	Y	Viton seal 90 Shore 'A'	Retaining screws DIN912-12.9/ Torque lb-in(Nm)	
037000	RF 01-R08	G 1/2"	0.5 (12,5)	0.6 (16)	1.1 (27)	0.5 (13)	2.1 (54)	0.9 (23)	0.69 (17,5)	1.49 (38)	0.79x0.10 (20,24x2,62)	M8x30	266 30
037010	RF 02-R10	G 3/4"	0.8 (20)	0.7 (18)	1.2 (30)	0.47 (12)	2.6 (65)	1.0 (26)	0.87 (22,2)	1.87 (47,6)	1.05x0.10 (26,65x2,62)	M10x30	531 (60)
037020	RF 03-R11	G 1"	1.0 (25)	0.8 (20)	1.3 (34)	0.5 (13)	2.7 (70)	1.1 (29)	1.03 (26,2)	2.06 (52,4)	1.29x0.10 (32,99x2,62)	M10x35	531 (60)
037030	RF 04-R12	G 1 1/4"	1.3 (32)	1.0 (22)	1.5 (38)	0.6 (14)	3.1 (80)	1.4 (36)	1.19 (30,2)	2.31 (58,6)	1.61x0.14 (40,86x3,53)	M10x40	531 (60)
037040	RF 05-R13	G 1 1/2"	1.5 (38)	0.9 (24)	1.6 (41)	0.7 (19)	3.7 (94)	1.6 (41)	1.41 (35,7)	2.76 (70)	1.73x0.14 (44,04x3,53)	M12x45	1062 (120)
037050	RF 06-R14	G 2"	1.9 (50)	1.1 (26)	1.8 (45)	0.8 (20)	4.0 (102)	1.9 (48)	1.69 (42,9)	3.06 (77,8)	2.36x0.14 (59,92x3,53)	M12x50	1062 (120)
055470*	RF 07-R16	G 2 1/2" *	2.5 (63)	1.2 (30)	1.9 (50)	0.7 (18)	4.5 (114)	2.2 (57)	1.99 (50,8)	3.50 (89)	2.86x0.14 (72,62x3,53)	M12x45	1062 (120)

* At RF07 only to 3045 PSI (210 bar) be allowed.

9.2 Low pressure type

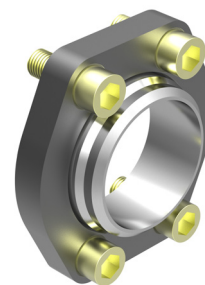
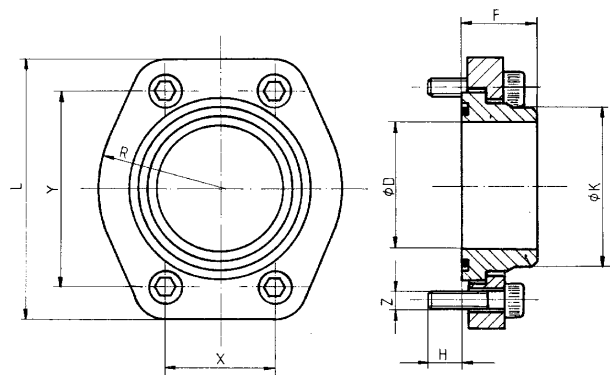

- Max. operating pressure 232 PSI

- Material: ST37



- Flange size SAE J518 code 61 / ISO 6162-1

- For FKM (Viton) seals contact Bucher Hydraulics

Order number	Order code	SAE flange size	D	K	F	H	L	R	X	Y	Viton seal 90 Shore 'A'	Retaining screws DIN 912-8.8 Torque Nm	Pipe ¹⁾ O/dia approx
062450	RN 07-S	2½"	2.5 (63)	2.9 (75)	1.3 (35)	0.6 (14)	4.7 (120)	2.5 (57)	2.0 (51)	3.5 (89)	2.73 x 0.14 (69,44x3,53)	M12x30 620 (70)	2.95 (75)
063880	RN 08-S	3½"	3.0 (76)	3.5 (88)			5.53 (140,5)	2.7 (68)	2.4 (62)	4.19 (106,5)	3.36 x 0.14 (85,32x3,53)	M16x40 1593 (180)	3.46 (88)
063890	RN 09-S	3½"	3.5 (89)	3.9 (100)	1.6 (40)	0.7 (19)	6.23 (158,5)	2.9 (73)	2.8 (70)	4.74 (120,3)	3.86 x 0.14 (98,02x3,53)	M16x40 1593 (180)	3.93 (100)
063900	RN 10-S	4"	4.1 (103)	4.5 (115)			6.6 (168)	3.1 (79)	3.1 (78)	5.1 (130)	4.36 x 0.14 (110,72x3,53)	M16x40 1593 (180)	4.53 (115)

1) We recommend the use of seamless precision steel tube to DIN 2391 with-wallthick. max 0.24 in (6 mm).

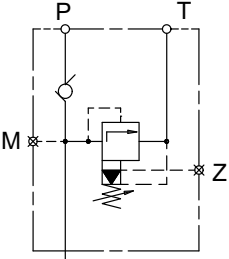
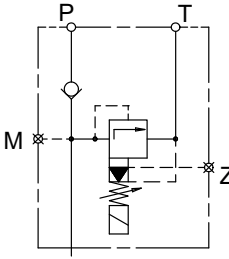
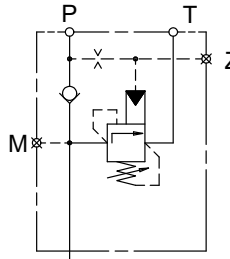
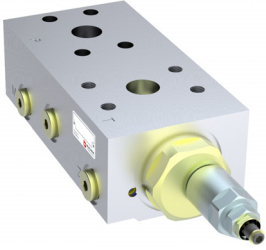
9.3 Bolt-on valves - SAE J518 code 61 / ISO 6162-1 pattern

Pressure relief valve $A \begin{smallmatrix} S \\ G \end{smallmatrix} DF / ASDH$	Pressure relief valve solenoid control $A \begin{smallmatrix} S \\ G \end{smallmatrix} DA$	Accumulator charging valve $AGSF$
		
		
Technical data sheet 100-P-000123	Technical data sheet 100-P-000119	Technical data sheet 100-P-0000124

9.3.1 Examples for mounted bolt-on valves

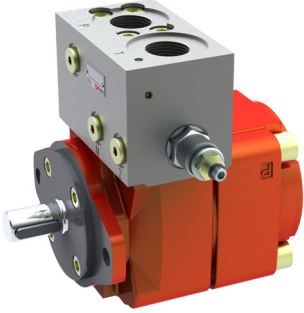
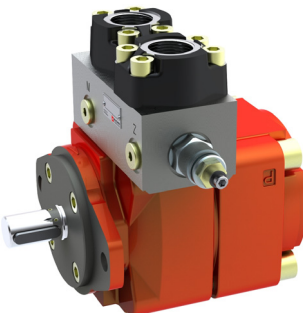
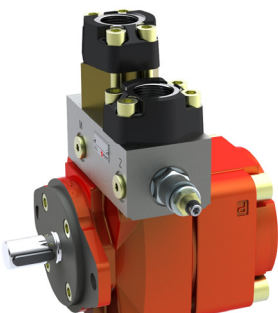
Bolt-on valve with threaded ports $AGDF$	Bolt-on valves with pipe flanges SAE ¹⁾ $ASDF+RF$	Bolt-on valve with pipe flanges SAE + RVSAE ²⁾ $ASDF+RF+RVSAE+DPSAE+ZPSAE$
		

IMPORTANT: For detailed informations on Bolt-on valves see www.bucherhydraulics.com

info.kl@bucherhydraulics.com

www.bucherhydraulics.com

© 2018 by Bucher Hydraulics GmbH, D-79771 Klettgau

All rights reserved.

Data is provided for the purpose of product description only, and must not be construed as warranted characteristics in the legal sense. The information does not relieve users from the duty of conducting their own evaluations and tests. Because the products are subject to continual improvement, we reserve the right to amend the product specifications contained in this catalogue.

Classification: 420.245. 200